

HOMEPOP

a Kinfine brand

Style Number : K4600

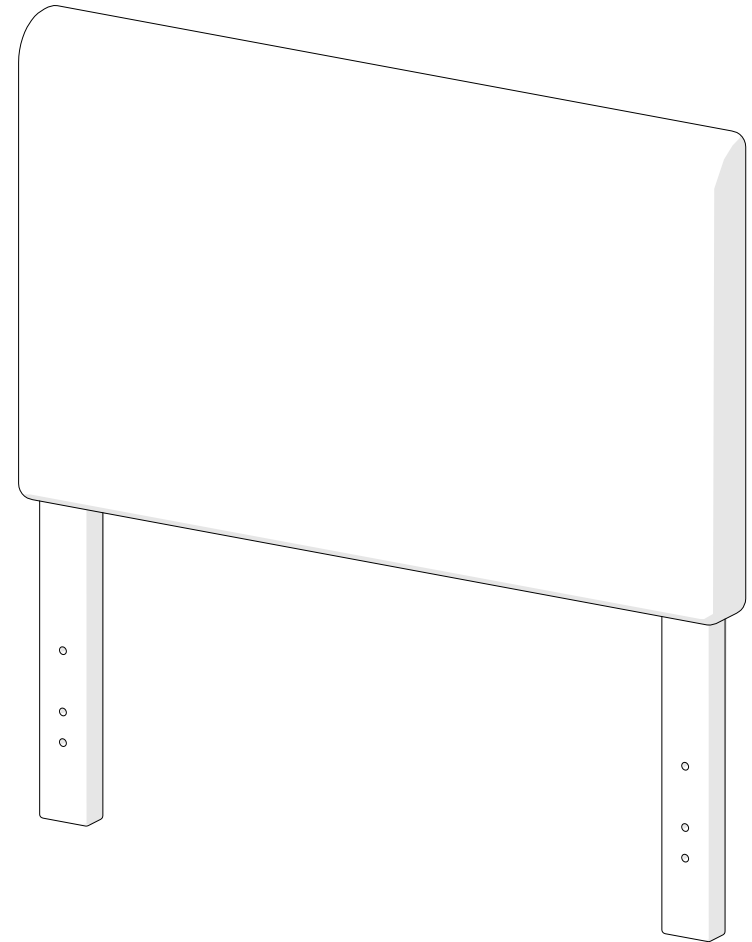

>>assembly instructions

Congratulations on your latest HomePop purchase.

Now what? Don't start sweating over this box of parts. This will be easy. We did the hard work for you. All you need to do is follow our simple instructions and you'll be on your way to transforming your room in no time. Good luck --though we're confident you won't need it.

before you begin

1. Check for damaged or missing parts. Customers can email service@kinfine.com or call 1-888-626-0888 to order missing supplies.
2. Use the carton as a working surface to prevent product damage during assembly.
3. Gather all tools prior to assembly.

table of contents



introduction	2
hardware	4
parts list	5
assembly	6 - 7

hardware

(A) x 4

5/16" x 1-3/4"
round hex screw

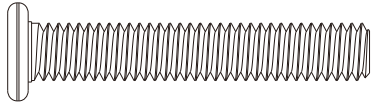
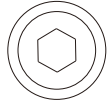

(B) x 6

1/4" x 1-3/4"
round hex screw

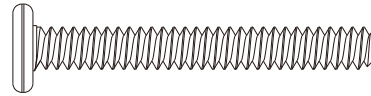

(C) x 4

5/16" lock washer



(D) x 4

7/8" flat washer

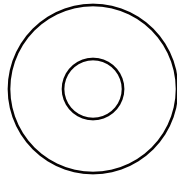

(E) x 6

1/4" lock washer



(F) x 6

3/4" flat washer

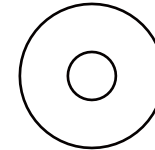

(G) x 1

5mm Ball end
Hex wrench

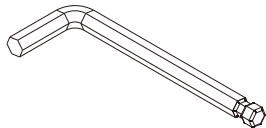

(H) x 1

4mm Ball end
Hex wrench

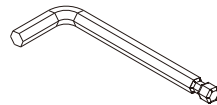

ITEM DESCRIPTION QUANTITY



①	headboard	1
②	right leg	1
③	left leg	1

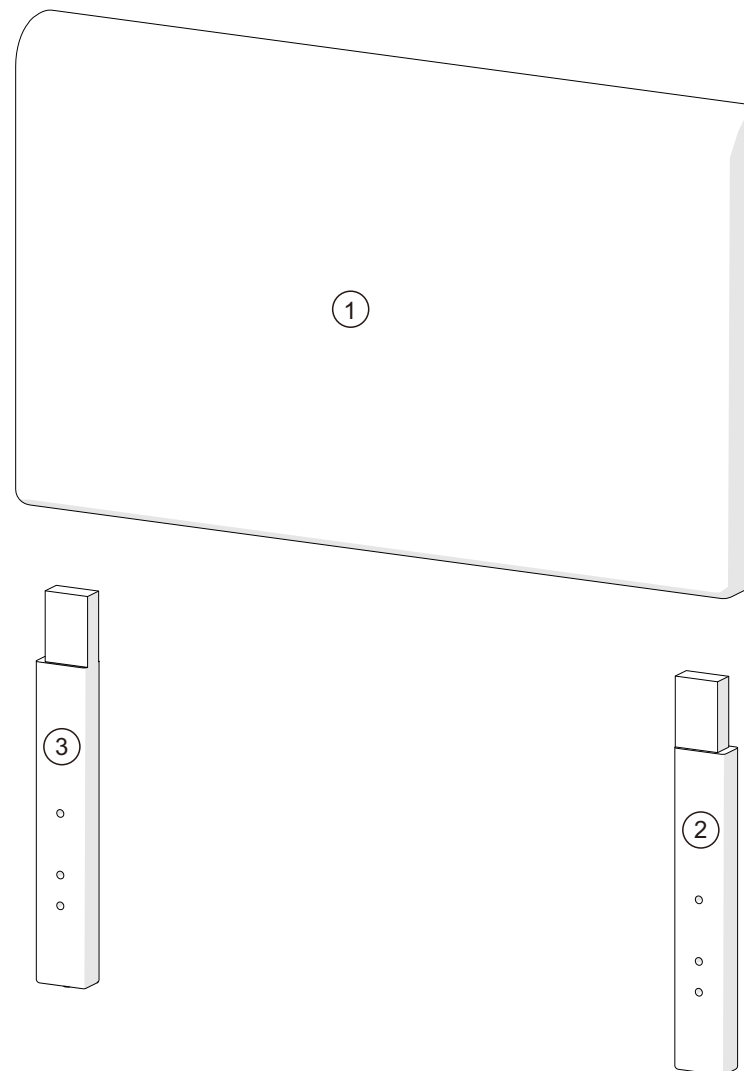

step 1.

1 Headboard facing down.

2

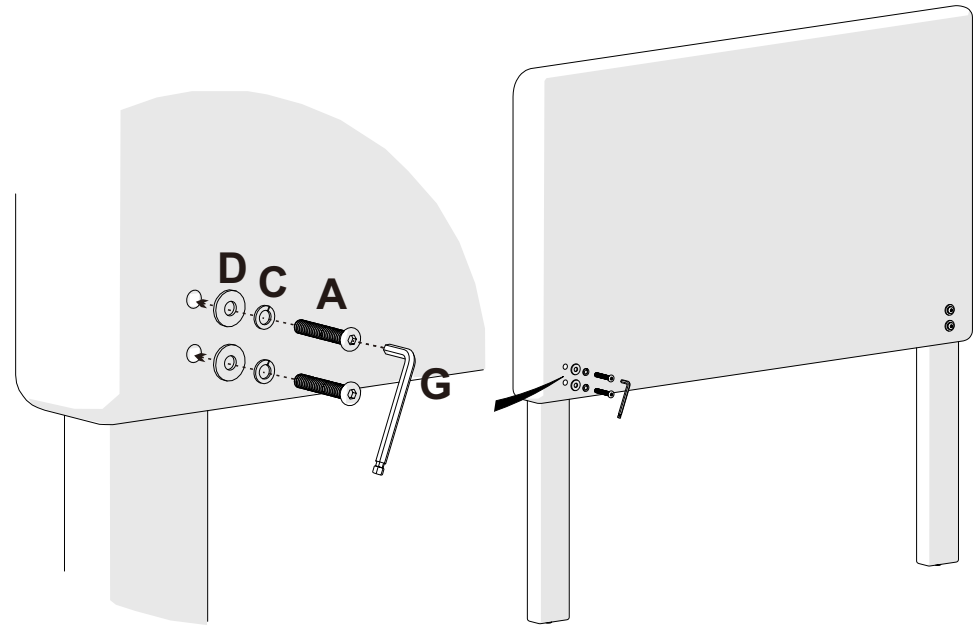
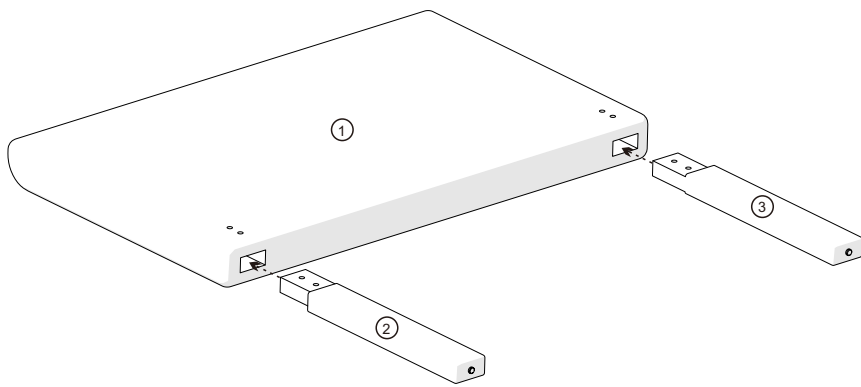

(A) x 4

5/16" x 1-3/4"
round hex screw

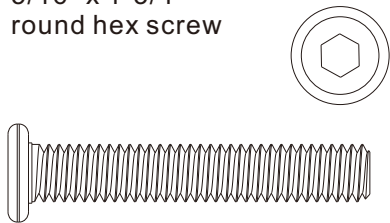

(C) x 4

5/16" lock washer

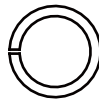

(D) x 4

7/8" flat washer

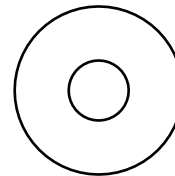

(G) x 1

5mm Ball end
Hex wrench

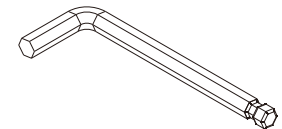

Please do not assemble with power tools

step 2.

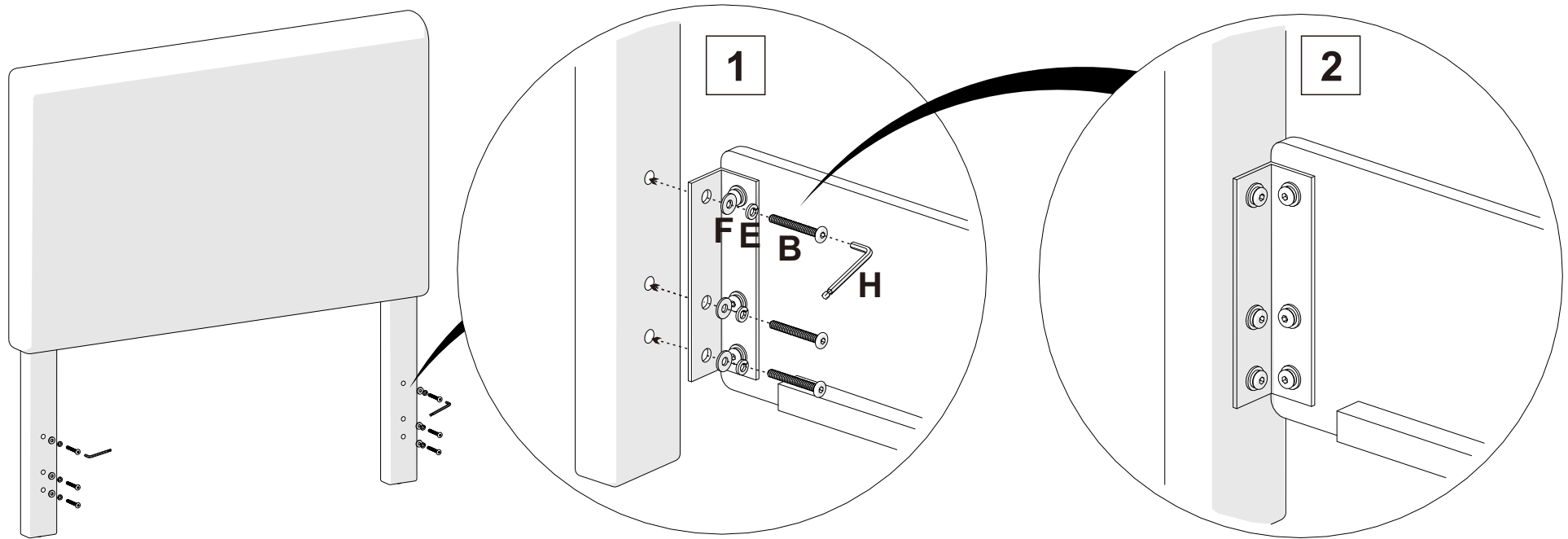

(B) x 6

1/4" x 1-3/4"
round hex screw

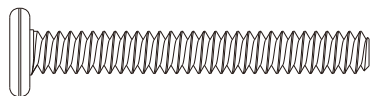

(E) x 6

1/4" lock washer



(F) x 6

3/4" flat washer

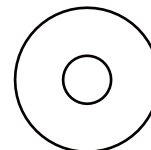

(H) x 1

4mm Ball end
Hex wrench

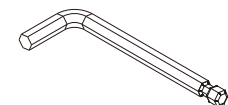

Please do not assemble with power tools